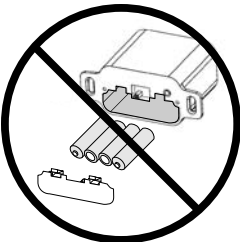

Table of Contents

Table of Contents.....	1
Warnings.....	1
Compatibility.....	1
Packing List.....	1
Installation.....	1
Wall Mount and Hand Held Remote.....	2
Remote Setup.....	2
Intermittent/Continuous Pilot.....	3
Direct Operation.....	4
Remote Operation.....	4
Battery Replacement.....	7
Display Fahrenheit or Celsius.....	8
Power Outages.....	8
Low Battery Indicator.....	8
Child-Proof Feature.....	8
Remote Programming.....	9

Warnings



**KEEP BATTERIES AND COVER
INSTALLED AT ALL TIMES**

The remote control system requires the batteries and battery cover to remain in place at all times. Once the batteries or cover are removed, the system may restart in standing pilot mode. If this occurs when the heater is in Remote Mode, you will not be able to turn off the heater manually from the battery box.

If you need to replace dead batteries, make sure to **turn the appliance off** before removing the batteries.

NOTE: If the batteries go dead, the system will operate normally as long as household power (120v AC) is present.



The transmitter and receiver are radio frequency devices. Placing the transmitter in or near metal may severely reduce the signal range.



Turn off power to the heater (unplug or turn off at the breaker).



Turn off the main gas supply to the appliance during appliance installation or maintenance.



REMOTE CONTROL / PILOT WARNING: Installing batteries in the battery holder or connecting the appliance to power may automatically initiate the CPI pilot mode, resulting in a lit pilot flame. Do not place combustibles inside the firebox.

Compatibility

The GreenSmart™ 2 remote is compatible with all Travis Industries GS2 products.

Packing List

- | | |
|--|---|
| • Transmitter | • Split-flow Harness (attached to IFC) |
| • Battery Box | • System Jumper (attached to IFC) |
| • Remote Wall Mount w Screws & Anchors | • Battery Box Harness (attached to IFC) |
| • Stepper Motor | • Fan/Light Harness (attached to IFC) |
| • Torx Wrench | • (2) Jumper Wires |
| • Remote Control DVD | • Power Lead (Eden, Northfield, Tree of Life, Berkshire only) |
| • GSR2 IFC | • (2) 4" Cable Ties |

Installation

HINT: If using a blower, make sure to have it on hand while installing the remote.

Refer to the installation instructions included with your appliance.

Wall Mount and Hand Held Remote

These instructions apply to both the wall mount and hand held remotes (both are identical in operation). For ease of reference, the wall mount button layout is shown in the instructions. If using the hand held remote, make sure to use the correct button by looking at the icon on the button (both remotes have icons on the buttons that are identical – see illustration below).

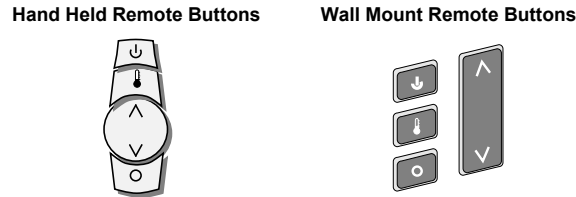

Remote Setup

Verify the Switch is on “REMOTE”

The battery holder has a switch built into it. This switch must remain in the REMOTE position for the remote to operate (see illustration below).

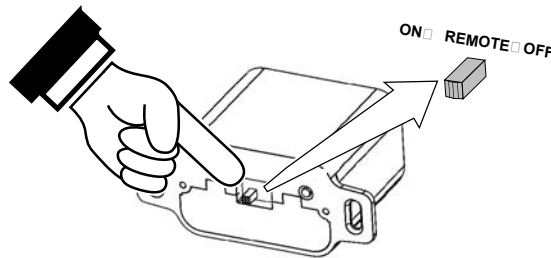

Synchronize the Transmitter to the IFC

The transmitter will need to be synchronized to the IFC (Integrated Fireplace Control) before the remote will work correctly. Synchronizing is done in the following two steps below (see illustration below):

1. Press the PRG (Program) button on the battery box (IFC will beep 3 times).
2. Press the “ON” button on the transmitter (IFC will beep 3 times).

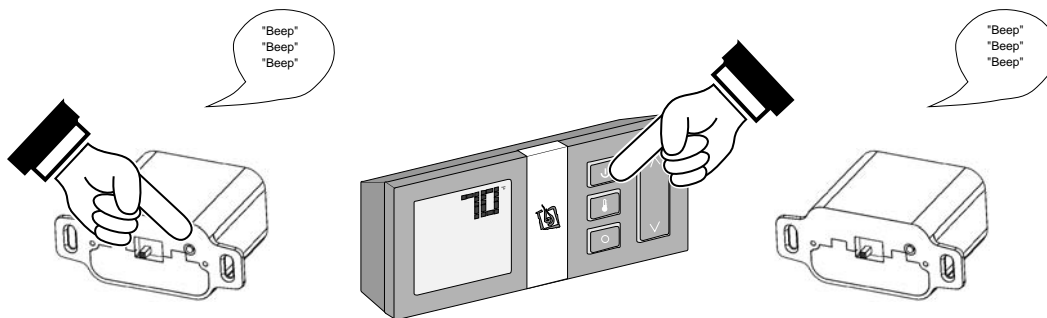

NOTE: If power is cut off to the IFC for an extended period of time, you may need to re-synchronize the remote.

Clearing the System Memory

This appliance uses an Integrated Fireplace Control (IFC) to store the unique code for the remote control. If you wish to clear the system memory, **MAKE SURE GAS IS TURNED OFF TO THE APPLIANCE** then press the PRG (Program) button for 10 seconds. The pilot will start to spark repeatedly, signifying all system memory has been cleared. The system will return to its original configuration: a remote will need to be synchronized; and, the system will operate under continuous pilot mode.

Intermittent/Continuous Pilot

This heater may run with the pilot continuously running or in intermittent mode. For most homeowners, the intermittent mode is preferred (this saves fuel, doesn't give off un-needed heat). However, in some situations the homeowner may prefer to switch the heater to continuous pilot. The most typical reasons for switching to continuous pilot are:

- Very Cold Conditions – in very cold conditions you may notice that the burner does not light quickly, and the flames lift off the burner. If this is situation, we recommend you switch to continuous pilot. This will create a slight draft in the vent, allowing for the burner to light quickly and draft correctly.
- Excessive Condensation on Glass After Startup – certain installations may encounter excessive fogging on the window after startup (not just the first time the heater was started). This is an aesthetic condition that may be remedied by switching the heater to continuous pilot.
- Cold Glass or Heater Front – in very cold conditions you may notice that the heater front and glass become very cold. To remedy this, switch the heater to continuous pilot.
- Frequent On / Off Operation – if you are frequently turning the heater on and off, you may wish to leave it in continuous pilot. This allows the burner to turn on more quickly, without pilot ignition delay.

Switching from Intermittent (IPI) to Continuous Pilot (CPI)

The pilot mode on this appliance is adjusted using the remote. With the remote in the off position (thermostat off, manual off), follow the directions below to adjust the pilot mode.

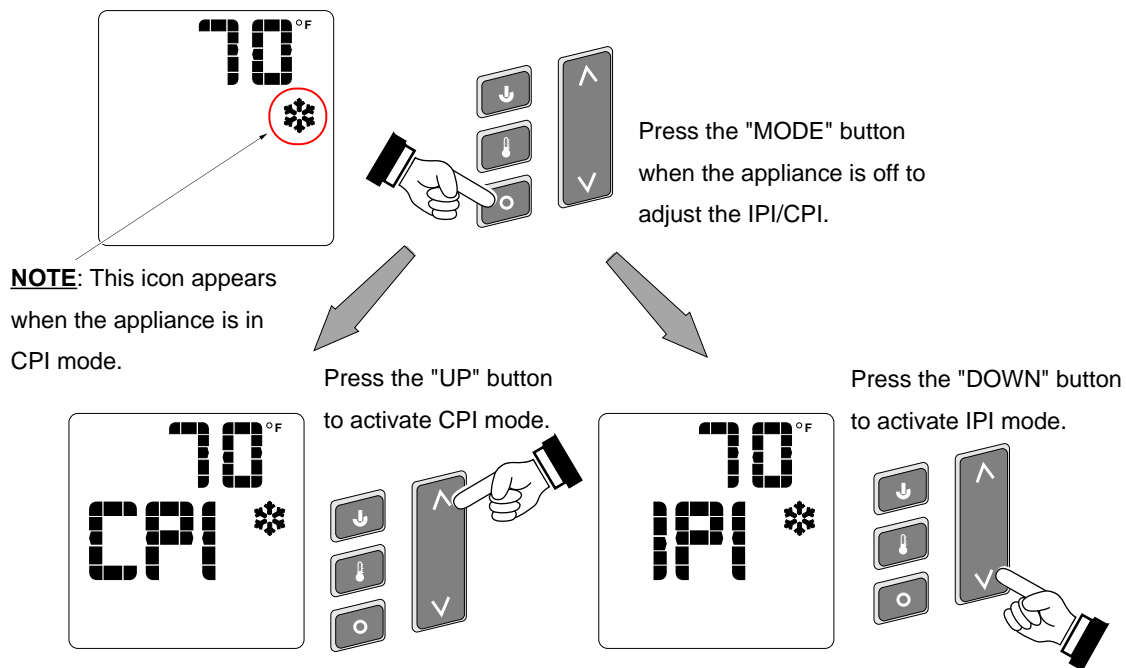

Direct Operation

The fireplace may be directly operated from the battery holder. The three positions are below (see below):

ON – Burner turns on (regardless of transmitter settings).

OFF – Burner turns off (regardless of transmitter settings).

REMOTE – Burner is controlled by the transmitter.

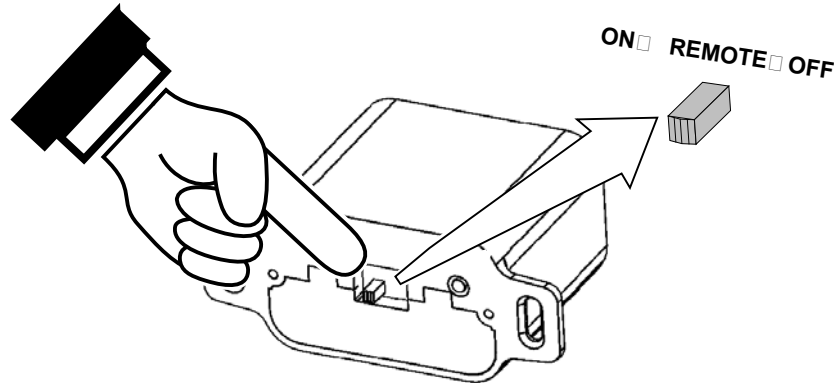

NOTE: When the battery holder switch is turned to ON or OFF, the mode settings (Flame Height, Comfort Control) will remain in the same state as before the switch was moved (i.e.: the IFC “remembers” the last setting). If you wish to adjust the mode settings use the transmitter mode button to adjust the settings (see “Mode Controls” on page 6). The thermostat and burner on/off operating functions will not work on the transmitter.

Remote Operation

When the switch on the battery holder is set to “REMOTE” the transmitter operates the fireplace. Once you understand how the transmitter works, you will be able to operate your fireplace quickly and easily.

Display Overview

The transmitter display has four main sections (see below).

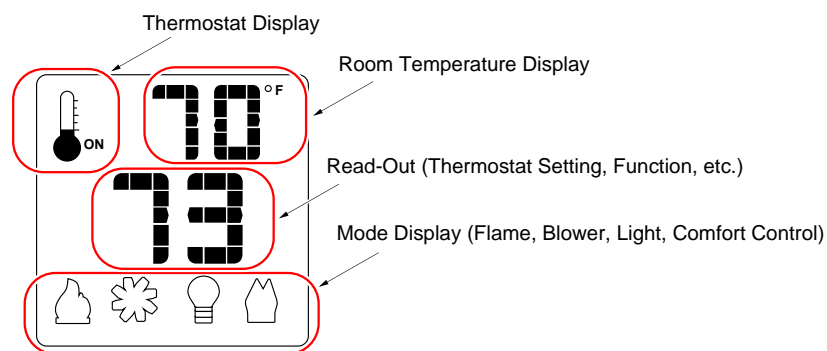

Listen for the “Beep”

Each time you press a button on the transmitter that controls the fireplace, a “beep” will come from the IFC. When you change thermostat target settings the IFC will not beep.

NOTE: When the batteries start to get low, the IFC will beep intermittently. When the batteries are nearly depleted, the IFC will no longer beep. See “**IFC Batteries**” on page 8).

Manual On-Off / Smart Thermostat / Standard Thermostat

Use the thermostat button to cycle through the three thermostat settings (see below).

Look here for the thermostat setting.

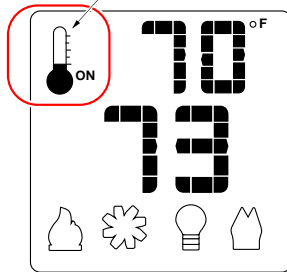

Press the thermostat button to cycle through the thermostat settings.

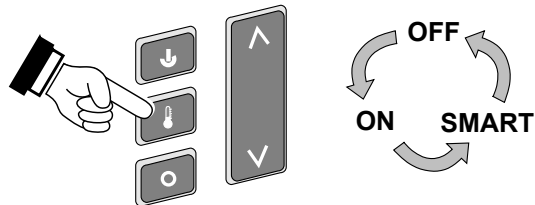

- **MANUAL ON/OFF** – The burner will turn on and off using the remote (see below). Press the On/Off button to control the burner. When off, the display will only show the current temperature.

When in manual setting, the word "OFF" will appear here.

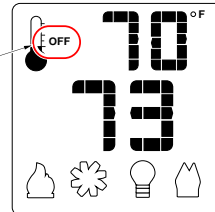

- **SMART THERMOSTAT** – While in smart thermostat, the transmitter will control the burner to achieve the target temperature (see below). Flame height will be adjusted up or down to allow operation without turning the burner on and off (also called “smart modulation”). To adjust the target temperature, press the UP and DOWN buttons until a suitable temperature is achieved.

When in smart thermostat setting, the word "SMART" will appear here.

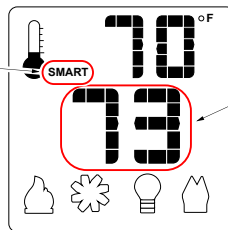

This is the target temperature on the read-out. Use the up or down buttons to adjust the target temperature.

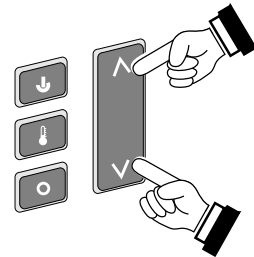

- **STANDARD THERMOSTAT** - While in standard thermostat setting, the transmitter will turn the burner on and off to achieve the target temperature (see below). To adjust the target temperature, press the up and down buttons until a suitable temperature is achieved.

When in standard thermostat setting, the word "ON" will appear here.

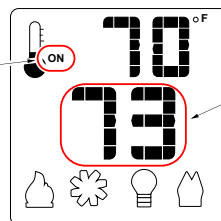

This is the target temperature on the read-out. Use the up or down buttons to adjust the target temperature.

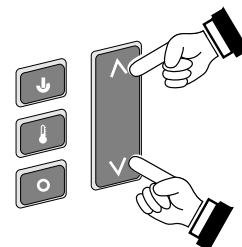

NOTE: If the transmitter batteries go dead while in thermostat setting (standard or smart), the appliance will shut off after approximately 24 hours.

Mode Controls (Flame, Blower, Light, Comfort Control)

Use the mode button to cycle through the four mode controls (see below).

Press the mode button to cycle through the mode settings.

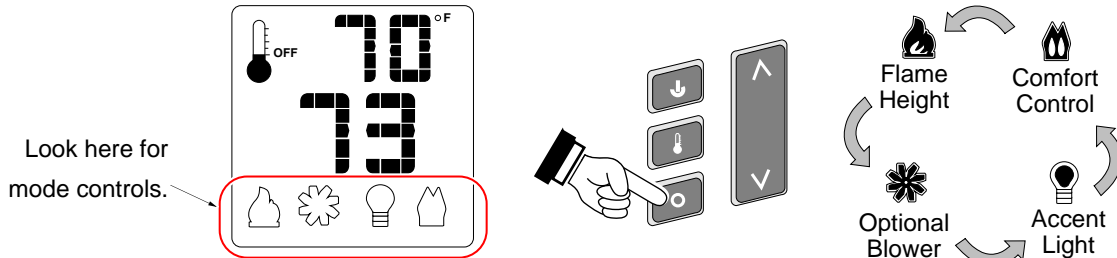

Flame Height

Flame height may be controlled using the UP and DOWN buttons when in Flame Height Mode (see below). The center display will display the 7 settings, from "OFF" to "HI" for full on.

NOTE: Flame height may not be adjusted if operating in Smart Thermostat setting.

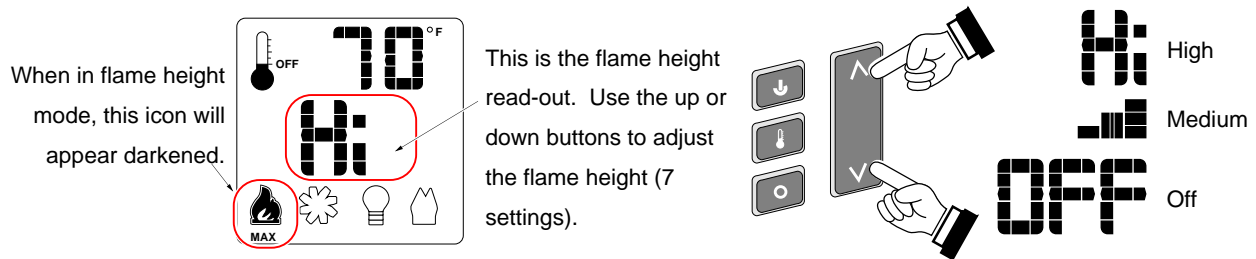

Blower Speed

The blower may be controlled using the up and down buttons when in Blower Speed Mode (see below). The center display will display the 7 settings, from "OFF" to "HI" for full on.

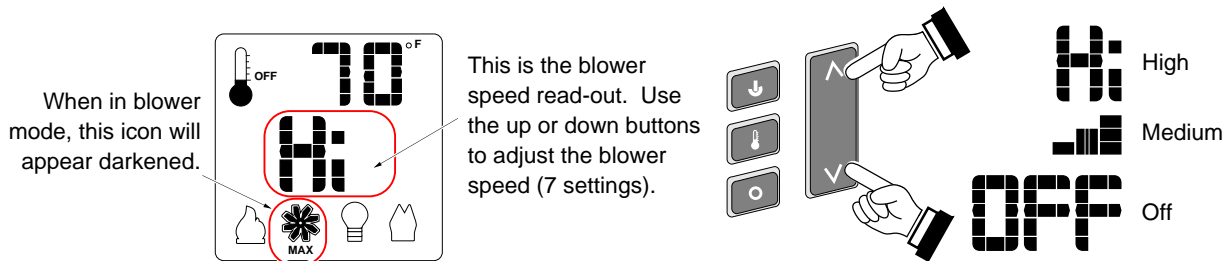

MANUAL MODE – BLOWER OPERATION



When in Manual Mode the blower will remain on, even if the burner is turned off and the heater cools.

Either manually turn the blower off, or turn off the heater by pressing the On/Off button. 

Accent Light (Aux)

The Accent Light (night light) inside the heater may be turned on and off using the up and down buttons when in Accent Light Mode (see below). The center display will display either “ON” or “OFF”.

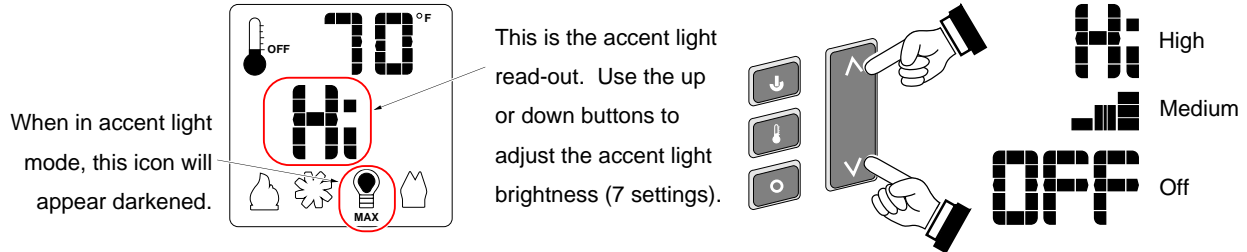

When in accent light mode, this icon will appear darkened.

This is the accent light read-out. Use the up or down buttons to adjust the accent light brightness (7 settings).

High
Medium
Off

HINT: If you wish to leave the accent light on while turning the burner off, adjust the Flame Height to “OFF” (see above).

Comfort Control (rear burner)

The comfort control (rear burner) may be turned on and off using the up and down buttons when in Comfort Control Mode (see below). The center display will display either “ON” or “OFF”.

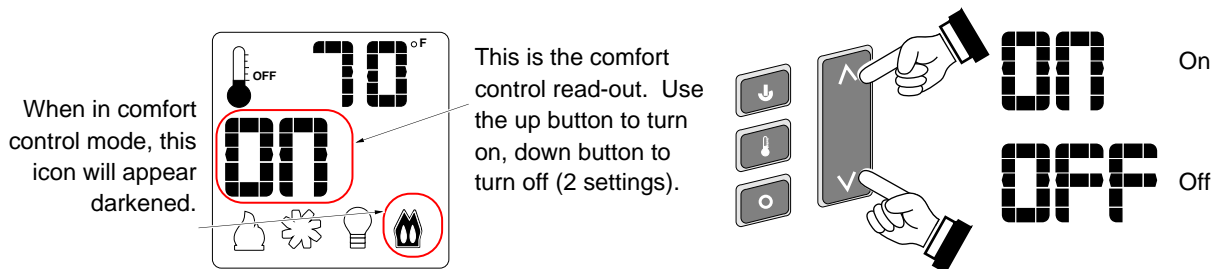

When in comfort control mode, this icon will appear darkened.

This is the comfort control read-out. Use the up button to turn on, down button to turn off (2 settings).

On
Off

Battery Replacement

Battery Installation

Install four AA batteries into the battery holder (see below). These batteries act as a power backup in case the household (AC) current goes out.

Transmitter Battery Installation

Install the three included AAA batteries into the remote (see below).

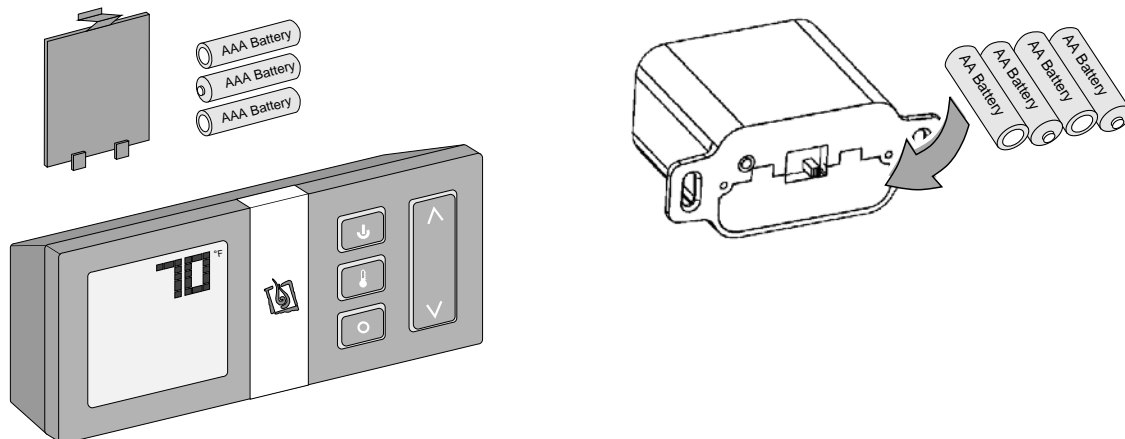

Display Fahrenheit or Celsius

- With the system in the “OFF” position, press both the MODE and THERMOSTAT buttons simultaneously to toggle between Fahrenheit (F) and Celsius (C).

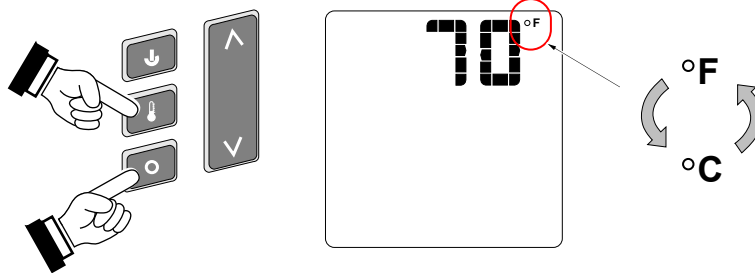

Power Outages

The remote will work if household current (AC power) is disconnected. The batteries inside the battery box will continue to power the heater but the accent light and blower will not operate.

Low Battery Indicator

Transmitter Batteries

The transmitter has a battery-level indicator. When it indicates low battery voltage (see below), install three new AAA alkaline batteries into the transmitter (see “Transmitter Battery Installation” on page 7).

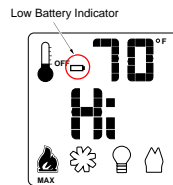

IFC Batteries

The IFC (Integrated Fireplace Control) will “beep” repeatedly when the batteries go low. Install four new AA alkaline batteries into the battery box when this occurs (see “Battery Installation” on page 7). In applications where the appliance is required to provide heat, we recommend replacing the batteries before each heating season.

Child-Proof Feature

The child proof feature disables the control buttons, preventing un-wanted use of the remote.

- Press both the MODE and UP buttons simultaneously to turn this feature on and off (see below).

HINT: This feature is especially useful while using the thermostat setting.

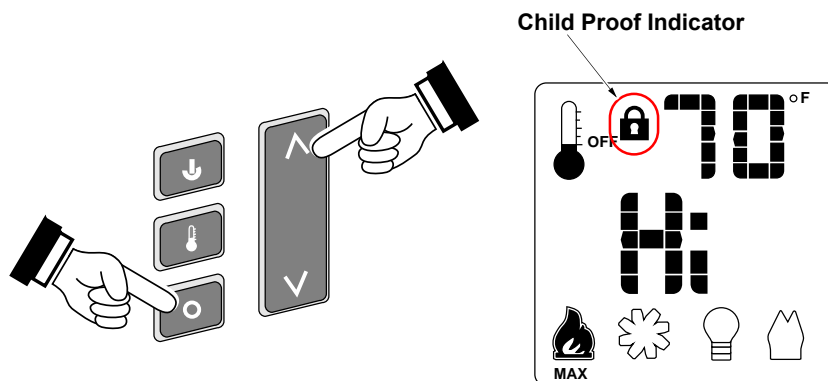

Remote Programming

The SIT GSR2 remote may be programmed to disable the thermostat or any of the modes (flame height, blower, light, comfort control, Standing Pilot *, or auxiliary power input). This allows you to tailor the remote to the appliance.

* We do not recommend disabling the standing pilot option for our gas appliances. This feature may be recommended for cold regions or installations with sub-optimal venting.

Compatibility

- GSR2 Appliances (1-Piece IFC controller with battery box)
- GSR1 Appliances (FCM Module and Receiver)
NOTE: The accent light is controlled via the AUX mode (works as on/off only).

How to Turn the Thermostat Feature On and Off

NOTE: The remote is shipped from the factory with the thermostat enabled.

- 1 Remove one battery from the remote.
- 2 Press down on the thermostat button while replacing the battery. This will toggle the thermostat function. Repeat this process to toggle the thermostat function to the desired setting.

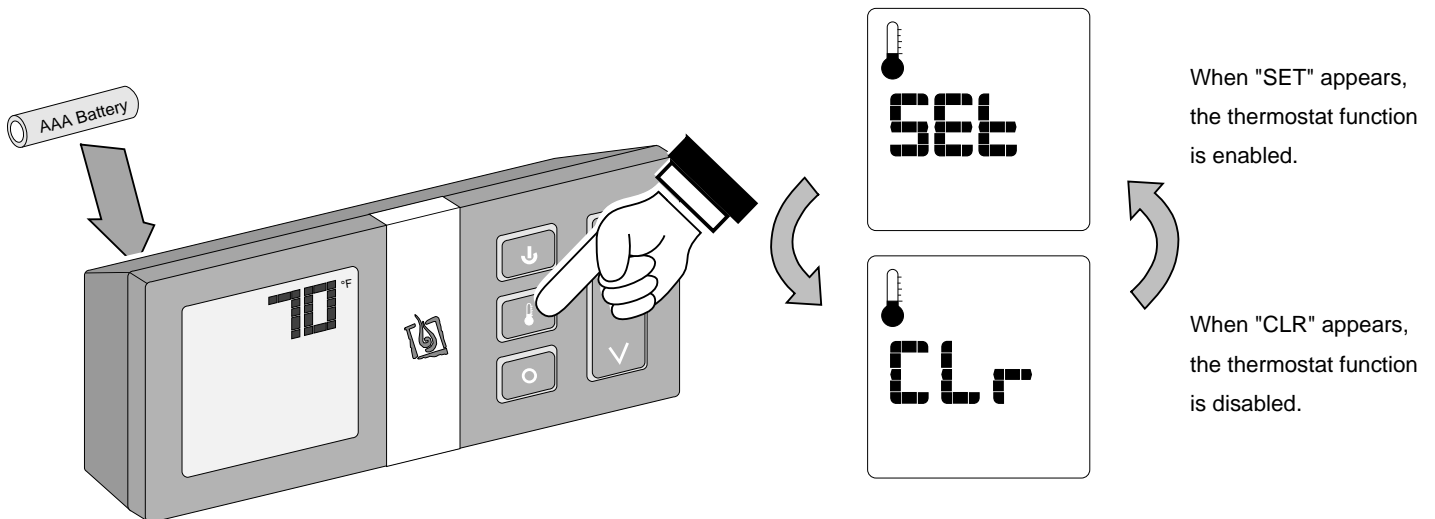



GreenSmart™ 2 Remote Setup Instructions

(SKU 99300688, 99300690, 99300692, 99300693)

Disabling Modes From the Remote

NOTE: The remote is shipped from the factory with all modes enabled except the auxiliary (AUX) function.

- 1 Remove one battery from the remote.
- 2 Press down on the on/off button and mode button while replacing the battery.
Make sure to keep the on/off button depressed during the following steps.

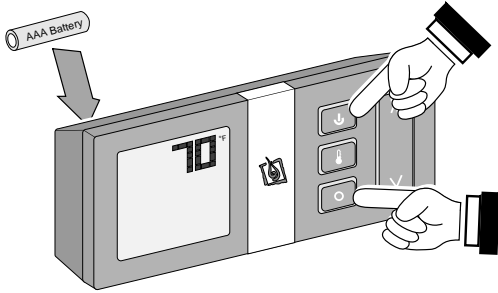

HINT: The easiest way to do this step is to place the top battery in the holder, slightly ajar. Then hold the the buttons down as you press the battery into place.



- 3 While keeping the on/off button depressed, press and release the mode button until the mode that needs to be changed is illuminated.

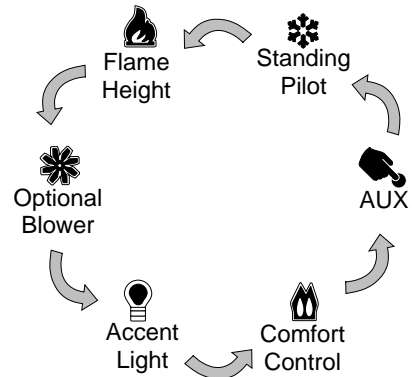
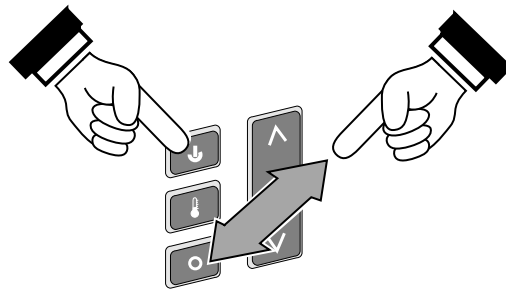
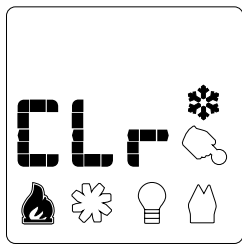

- 4 With the desired mode illuminated (the illustration below shows the AUX mode illuminated), press the "up" or "down" button to activate or clear the mode being addressed. Make sure to keep the on/off button depressed during this process.

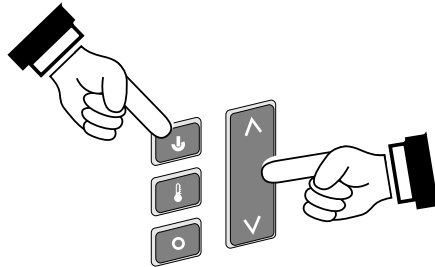
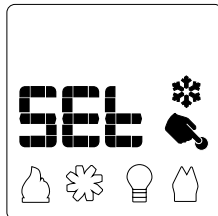

^ SET

Press the "up" button to activate ("SET") the mode selected.

∨ CLR

Press the "down" button to clear ("CLR") the mode selected.

- 5 Release the on/off button to complete programming.